

Oil Seals

Ordering Information

Part Number: Prefix - ID X OD X H

Example: MOS - 14 X 24 X 7

Sizes are in stock where prices are shown.

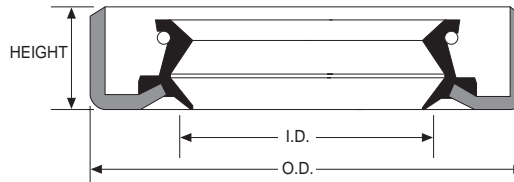

Styles



MOS

Seal: Rubber
Case: Steel
Temperature: -65 to +225° F
Pressure: 10 PSI @ 1000 fpm

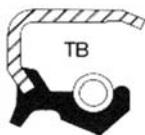
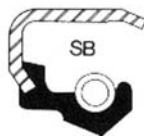

Sample profiles of Oil Seal Styles.

PART NUMBER	LIST
MOS-10X19X7TC	\$ 2.97
MOS-10X20X7TC	2.97
MOS-10X22X7TC	3.00
MOS-12X16X3VG	2.87
MOS-12X19X5SC	2.73
MOS-12X19X7TC	2.97
MOS-12X20X4TC	2.97
MOS-12X20X5TC	2.97
MOS-12X22X7TC	3.00
MOS-12X24X7TC	3.00
MOS-12X25X7TC	3.07
MOS-12X26X7TC	3.07
MOS-12X28X7TC	3.07
MOS-13X22X5SC	2.77
MOS-13X25X4SC	2.83
MOS-13X25X7SC	3.07
MOS-14X20X3TC	2.60
MOS-14X22X4TC	3.00
MOS-14X24X6TC	3.00
MOS-14X24X7TC	3.00
MOS-14X25X5TC	3.00
MOS-14X25X7SC	2.80
MOS-14X26X7TC	3.07
MOS-14X28X7TC	3.07
MOS-14X32X7TC	3.30
MOS-15X24X7TC	2.77
MOS-15X25X7TC	3.00
MOS-15X30X7TC	3.10
MOS-15X32X7TC	4.03
MOS-15X35X7TC	3.63
MOS-16X20X2.5VM	2.77
MOS-16X26X6TC	3.07
MOS-16X28X7TC	3.07
MOS-16X30X7TC	3.07
MOS-16X32X7TC	3.30
MOS-16X35X7TC	3.63
MOS-17X23X3VG	2.53
MOS-17X28X7TC	3.07
MOS-17X29X7TC	3.07
MOS-17X30X6TC	3.07
MOS-17X30X7TC	3.17

PART NUMBER	LIST
MOS-17X30X8TC	\$ 3.07
MOS-17X32X7TC	3.30
MOS-17X35X8TC	3.30
MOS-17X40X5TC	4.03
MOS-17X40X7SC	3.63
MOS-17X47X8TC	4.67
MOS-18X24X3KC	2.77
MOS-18X26X4SC	2.83
MOS-18X28X4SC	2.83
MOS-18X28X7TC	3.77
MOS-18X30X7TC	4.03
MOS-18X30X7TM	4.30
MOS-18X30X8TC	3.07
MOS-18X32X7TC	3.63
MOS-18X35X7TC	3.63
MOS-18X40X7TC	3.97
MOS-19X29X7TC	3.07
MOS-19X30X7TC	3.30
MOS-19X32X8TEC	4.00
MOS-19X35X7TC	3.63
MOS-20X26X4VC	3.23
MOS-20X26X4VM	3.30
MOS-20X28X4TM	4.30
MOS-20X30X7TC	3.07
MOS-20X31X7SC	3.30
MOS-20X32X7TC	3.63
MOS-20X33X5TC	3.63
MOS-20X34X7TC	3.63
MOS-20X35X6TC	3.63
MOS-20X35X7TC	3.67
MOS-20X36X7TC	3.97
MOS-20X38X8TC	4.03
MOS-20X40X10TC	4.03
MOS-20X40X7TC	4.03
MOS-20X42X7TC	4.30
MOS-20X45X7TC	4.30
MOS-20X47X7TC	4.67
MOS-20X52X10TC	5.13
MOS-22X28X4KC	3.27
MOS-22X32X5SC	3.30
MOS-22X32X7SC	3.30

Oil Seals

Ordering Information

Part Number: Prefix - ID X OD X H

Example: MOS - 14 X 24 X 7

Sizes are in stock where prices are shown.

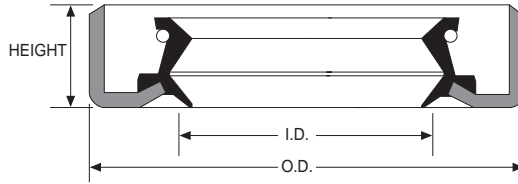

Styles



MOS

Seal: Rubber
 Case: Steel
 Temperature: -65 to +225° F
 Pressure: 10 PSI @ 1000 fpm

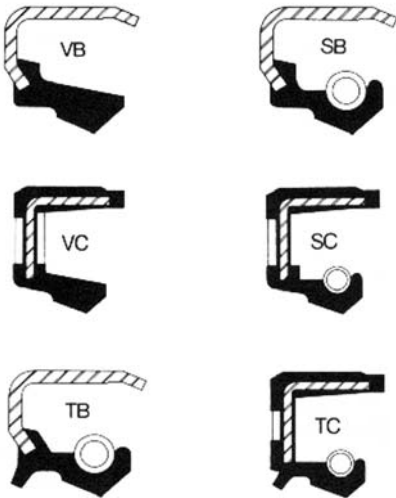

Sample profiles of Oil Seal Styles.

PART NUMBER	LIST
MOS-22X32X7TC	\$ 3.63
MOS-22X35X5TC	3.63
MOS-22X35X6TC	3.63
MOS-22X35X7TC	3.63
MOS-22X35X8TC	3.63
MOS-22X36X7TC	3.97
MOS-22X38X7TC	4.63
MOS-22X40X7TC	4.63
MOS-22X42X7SCY	4.30
MOS-22X42X7TC	4.63
MOS-23X34X8TC	4.57
MOS-23X35X7TC	4.23
MOS-24X32X4VG	3.63
MOS-24X35X7TC	4.30
MOS-24X36X7TC	4.23
MOS-24X40X7TC	4.63
MOS-24X52X10TC	5.77
MOS-250X280X15TC	75.91
MOS-25X32X4VVM	8.37
MOS-25X35X6TC	4.23
MOS-25X35X6VTC	12.33
MOS-25X35X7SC	3.30
MOS-25X35X7TC	4.23
MOS-25X35X7VTC	12.33
MOS-25X36X7TC	4.23
MOS-25X38X7TC	4.63
MOS-25X38X8TC	4.63
MOS-25X40X10TC	4.27
MOS-25X40X5TC	3.93
MOS-25X40X7SC	3.60
MOS-25X40X7TC	3.93
MOS-25X40X8SB	4.27
MOS-25X40X8TC	3.93
MOS-25X42X6SC	3.93
MOS-25X42X6TC	4.30
MOS-25X42X7TC	4.30
MOS-25X44X7TC	4.30
MOS-25X45X10TC	4.30
MOS-25X45X8TC	4.30
MOS-25X47X7TC	5.30
MOS-25X47X8TC	4.67

PART NUMBER	LIST
MOS-25X48X8TC	\$ 4.67
MOS-25X50X10TC	4.67
MOS-25X52X10TC	5.30
MOS-25X52X7TC	5.13
MOS-25X62X12TC	6.27
MOS-25X62X7TC	6.17
MOS-26X35X7TC	3.50
MOS-26X37X7TC	3.93
MOS-26X38X8TC	2.93
MOS-26X40X7TC	3.93
MOS-26X52X8TC	5.13
MOS-27X38X7TC	3.93
MOS-27X41X10SC	3.93
MOS-27X43X8TC	4.30
MOS-28X35X5TC	3.60
MOS-28X37X6TC	5.57
MOS-28X38X7TC	3.93
MOS-28X40X5TC	4.30
MOS-28X40X7TC	4.30
MOS-28X42X7TC	4.30
MOS-28X42X8TC	4.30
MOS-28X43X7SC	3.93
MOS-28X47X10TC	4.67
MOS-28X47X7TC	4.67
MOS-28X48X11TC	4.67
MOS-28X48X8TC	4.67
MOS-30X37X4TC	5.57
MOS-30X38X4SC	3.60
MOS-30X40X7SB	4.27
MOS-30X40X7TC	3.93
MOS-30X42X6TC	4.30
MOS-30X42X7TC	4.30
MOS-30X42X8TC	4.30
MOS-30X43X8TC	4.30
MOS-30X45X6TC	4.30
MOS-30X45X8TC	4.30
MOS-30X46X8TC	4.67
MOS-30X47X7TC	4.67
MOS-30X47X8TC	4.80
MOS-30X48X8TC	4.67
MOS-30X50X7TC	4.67

Oil Seals

Ordering Information

Part Number: Prefix - ID X OD X H

Example: MOS - 14 X 24 X 7

Sizes are in stock where prices are shown.

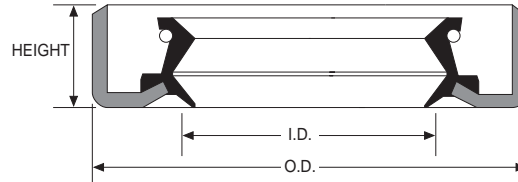

Styles



MOS

Seal: Rubber
Case: Steel
Temperature: -65 to +225° F
Pressure: 10 PSI @ 1000 fpm

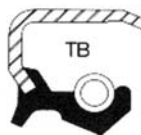
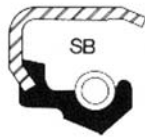

Sample profiles of Oil Seal Styles.

PART NUMBER	LIST	PART NUMBER	LIST
MOS-30X52X7TC	\$ 4.80	MOS-35X72X8TC	\$ 8.73
MOS-30X52X8TC	4.90	MOS-35X80X10TC	8.73
MOS-30X55X7TC	5.13	MOS-36X47X7TC	5.53
MOS-30X60X8TC	5.30	MOS-36X58X10TC	6.67
MOS-30X62X7SC	5.60	MOS-37X50X7TC	6.10
MOS-30X62X7TC	6.10	MOS-38X50X7TC	6.10
MOS-30X72X10TC	7.33	MOS-38X52X10TC	3.67
MOS-32X42X7TC	4.30	MOS-38X52X7TC	6.10
MOS-32X43X7TC	4.30	MOS-38X55X8TC	6.10
MOS-32X44X8TC	4.30	MOS-38X58X10TC	5.13
MOS-32X45X7TC	4.30	MOS-40X50X8TC	6.10
MOS-32X48X7TC	4.70	MOS-40X52X5TC	6.10
MOS-32X48X8TC	4.70	MOS-40X52X7SC	4.70
MOS-32X52X11TC	5.13	MOS-40X52X7TC	6.10
MOS-32X52X7SC	4.67	MOS-40X52X8TC	6.10
MOS-32X52X8TC	3.67	MOS-40X54X7TC	6.10
MOS-32X55X8TC	5.13	MOS-40X55X7TC	6.10
MOS-32X72X10TC	7.33	MOS-40X55X8TC	6.10
MOS-33X40X3VM	4.27	MOS-40X56X7TC	6.67
MOS-33X45X7SC	3.93	MOS-40X58X10SC	5.13
MOS-33X50X8TC	4.67	MOS-40X58X8TC	6.67
MOS-34X52X10SC	4.30	MOS-40X60X10TC	7.27
MOS-34X54X11TC	5.13	MOS-40X62X10TC	7.27
MOS-34X72X10SC	6.73	MOS-40X62X12TC	6.17
MOS-35X42X4VC	3.60	MOS-40X62X7TC	4.83
MOS-35X45X5VM	8.84	MOS-40X68X10SC	6.70
MOS-35X45X7TC	4.53	MOS-40X68X10TC	11.90
MOS-35X46X7TC	4.70	MOS-40X68X7TC	8.00
MOS-35X47X7TC	4.70	MOS-40X72X10TC	8.93
MOS-35X48X8TC	5.53	MOS-40X80X10TC	10.53
MOS-35X50X10TC	5.67	MOS-42X52X8TC	6.10
MOS-35X50X7TC	5.53	MOS-42X55X7TC	6.10
MOS-35X50X8TC	5.53	MOS-42X55X8TC	6.10
MOS-35X52X7TC	6.10	MOS-42X60X9TC	7.27
MOS-35X52X7VTF	13.40	MOS-42X62X8TC	7.27
MOS-35X52X8TC	4.93	MOS-42X65X12TC	7.27
MOS-35X54X8TC	6.10	MOS-44X60X7TC	7.27
MOS-35X55X11TC	6.10	MOS-44X62X10TC	4.43
MOS-35X55X12TC	6.10	MOS-44X62X8TC	7.27
MOS-35X55X8TC	6.10	MOS-45X52X4VB	4.37
MOS-35X62X10TC	6.67	MOS-45X55X4VC	4.23

Oil Seals

Ordering Information

Part Number: Prefix - ID X OD X H

Example: MOS - 14 X 24 X 7

Sizes are in stock where prices are shown.

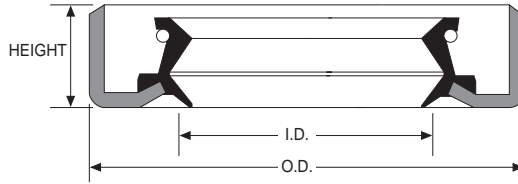

Styles



MOS

Seal: Rubber
 Case: Steel
 Temperature: -65 to +225° F
 Pressure: 10 PSI @ 1000 fpm

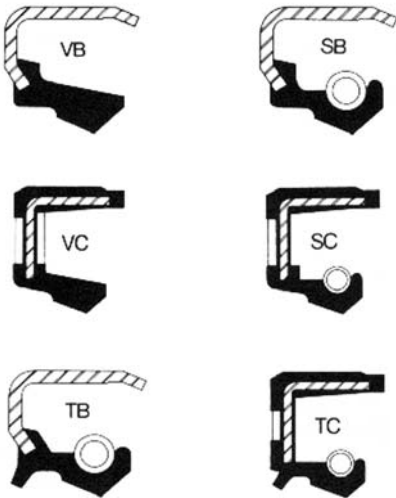

Sample profiles of Oil Seal Styles.

PART NUMBER	LIST
MOS-45X58X7TC	\$ 6.67
MOS-45X60X7TC	5.60
MOS-45X62X7TC	6.17
MOS-45X62X7VTC	14.13
MOS-45X62X8TC	6.17
MOS-45X62X9SC	6.17
MOS-45X65X12TC	6.17
MOS-45X65X7TC	6.17
MOS-45X65X8TC	6.17
MOS-45X68X10TC	6.73
MOS-45X68X12TC	8.00
MOS-45X68X8TC	6.70
MOS-45X72X10TC	7.33
MOS-45X72X8TC	7.33
MOS-45X80X10TC	8.07
MOS-46X65X9TC	6.17
MOS-46X66X10TC	6.73
MOS-48X62X8TC	6.17
MOS-48X65X10TC	6.17
MOS-48X70X10TC	6.73
MOS-48X70X11TC	6.80
MOS-48X72X10TC	7.33
MOS-48X80X8TC	8.07
MOS-50X60X8TC	5.60
MOS-50X62X7TC	6.10
MOS-50X65X6TC	6.17
MOS-50X65X8SB	6.67
MOS-50X65X8TC	6.17
MOS-50X68X8TC	6.70
MOS-50X70X10TC	6.70
MOS-50X72X12TC	7.33
MOS-50X72X8TC	7.33
MOS-50X80X12TC	8.07
MOS-50X80X8TC	8.07
MOS-50X90X10TC	9.67
MOS-52X62X8TC	6.10
MOS-52X68X8TC	6.73
MOS-55X68X8TC	6.70
MOS-55X70X7SC	6.17
MOS-55X70X8TC	6.70
MOS-55X72X10TC	7.33

PART NUMBER	LIST
MOS-55X72X8TC	\$ 7.33
MOS-55X75X10TC	7.33
MOS-55X78X12TC	8.07
MOS-55X80X10TC	8.07
MOS-55X85X10TC	8.80
MOS-55X90X10TC	9.67
MOS-56X72X8TC	7.33
MOS-60X75X8TC	7.33
MOS-60X78X9TC	8.07
MOS-60X80X10TC	8.07
MOS-60X80X12TC	8.07
MOS-60X80X7VTC	21.20
MOS-60X80X8VTF	23.87
MOS-60X80X9TC	8.07
MOS-60X82X12TC	8.07
MOS-60X85X10TC	8.80
MOS-60X95X10TC	10.60
MOS-62X80X10TC	8.07
MOS-62X85X8TC	8.80
MOS-63X90X10SC	8.80
MOS-65X77X12TB	8.10
MOS-65X85X10TC	8.80
MOS-65X85X8TC	8.80
MOS-65X88X12TC	9.67
MOS-65X90X10TC	9.67
MOS-68X90X10TC	9.67
MOS-70X100X10TC	10.63
MOS-70X110X10TC	14.00
MOS-70X80X10TC	8.07
MOS-70X85X8TC	8.80
MOS-70X90X10TC	9.67
MOS-70X90X10VTF	28.30
MOS-70X90X12TC	9.67
MOS-70X90X7TC	9.67
MOS-70X95X13TC	10.60
MOS-75X100X10TC	11.63
MOS-75X100X12VSC	28.30
MOS-75X105X13TC	12.77
MOS-75X95X10TC	10.63
MOS-80X100X10TC	11.63
MOS-80X100X12TC	11.63

Oil Seals

Ordering Information

Part Number: Prefix - ID X OD X H

Example: MOS - 14 X 24 X 7

Sizes are in stock where prices are shown.

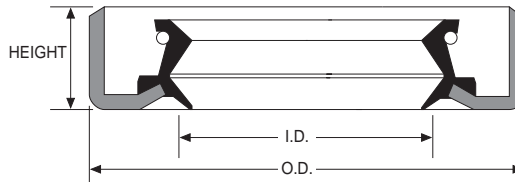

Styles



MOS

Seal: Rubber
Case: Steel
Temperature: -65 to +225° F
Pressure: 10 PSI @ 1000 fpm

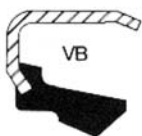

VB



SB



VC



SC

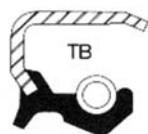

TB



TC

Sample profiles of Oil Seal Styles.

PART NUMBER	LIST
MOS-80X100X7TC	\$11.63
MOS-80X105X10TC	12.77
MOS-80X105X13TC	12.77
MOS-80X110X10TC	14.00
MOS-80X110X12TC	17.17
MOS-85X100X12TC	11.63
MOS-85X105X10TC	12.77
MOS-85X110X12TC	14.00
MOS-85X110X13TC	14.00
MOS-85X120X12TC	16.87
MOS-8X14X4TC	3.07
MOS-8X16X7TC	2.97
MOS-8X18X5TC	2.97
MOS-8X22X7TC	3.00
MOS-90X105X10TC	12.77
MOS-90X110X12TC	14.00
MOS-90X115X13TB	18.34
MOS-90X120X13TC	16.87
MOS-95X120X12TC	16.87
MOS-95X130X12TC	20.34
MOS-98X130X13SB	22.14
MOS-100X125X12TC	18.54
MOS-105X130X12TC	21.94
MOS-105X135X14TC	21.40
MOS-110X130X12SC	20.34
MOS-110X130X12TC	22.40
MOS-110X140X12TC	22.50
MOS-115X140X13TC	22.50
MOS-120X150X12TC	24.90
MOS-120X155X15TC	26.24
MOS-125X150X12VTF	88.38
MOS-130X150X10SC	33.04
MOS-130X160X12TC	27.57
MOS-140X160X12TC	27.57
MOS-140X170X13TC	24.24
MOS-150X180X15TC	35.17
MOS-160X200X12TC	43.17
MOS-175X200X15TC	43.17
MOS-190X220X15TC	53.01
MOS-200X230X13TC	58.71